

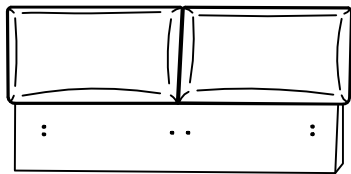
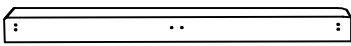

Assembly Instruction

组装说明书

Number	Parts Identification		Quantities
编号	部件明细		数量
A		Headboard 床头	1
B		Footboard 床尾	1
C	 Side Rail	床侧	2
D	 Middle Slat	床中连杆	1
E		Slat 床铺板	1

Number	Hardware List		Quantities
编号	五金明细		数量
1		螺杆 Big Screw	48
2		木螺丝 Small Screw	8
3		Footboard & Side Rail Support 斜拉铁	4
4		L-shaped angle Bracket L 型角铁	4
5		U-shaped angle Bracket U 型角铁	2
6		Adjustable support feet 可调节支撑脚	6

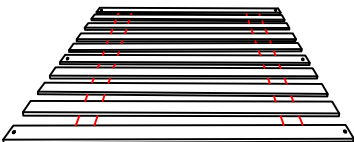
步骤1:

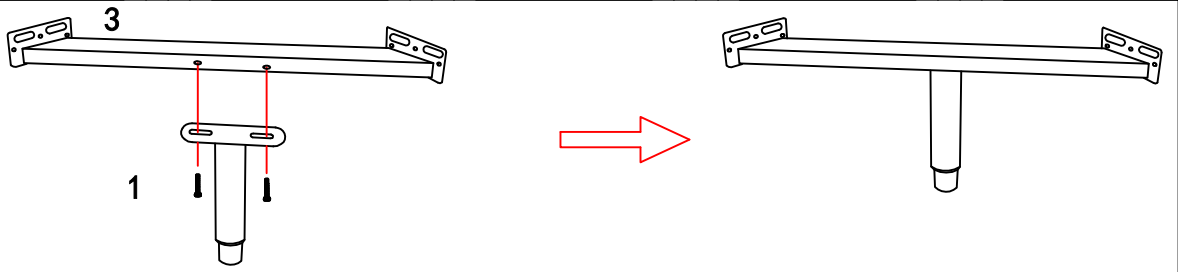

6 a: 用螺杆1把可调节支撑脚6和斜拉撑4固定

a: Use the Big Screw ① to secure the Adjustable support feet ⑥ to the Footboard & Side Rail Support ③.

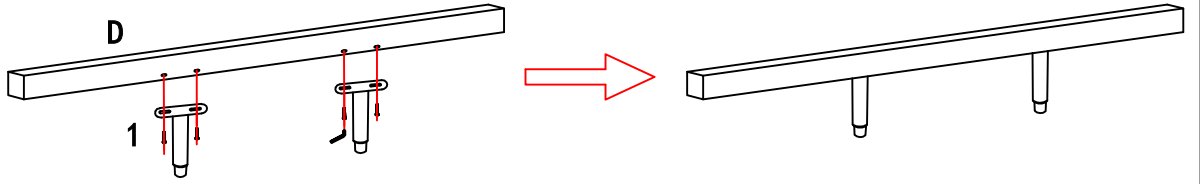

6 b: 用螺杆1把可调节支撑脚6和床中连杆D固定

b: Use the Big Screw ① to secure the Adjustable support feet ⑥ to the Middle Slat [D].

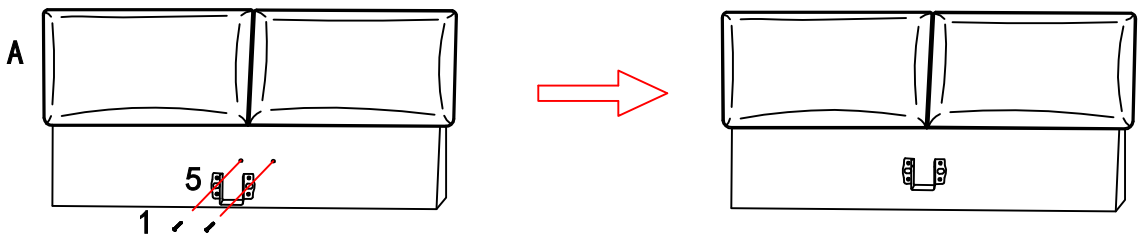

c: 用螺杆1把U型角铁固定6固定在床头A上 (位置图示)

C: Use the Big Screw ① to secure the U-shaped angle Bracket ⑤ to the Headboard [A] (Location as in Pic)

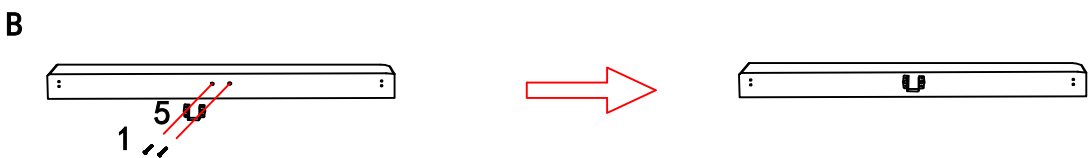

d: 用螺杆1把U型角铁固定6固定在床尾B上 (位置图示)

d: Use the Big Screw ① to secure the U-shaped angle Bracket ⑤ to the Footboard [B] (Location as in Pic)



e: 用螺杆1把L型角铁固定4固定在床侧C上 (位置图示, 注意L型角铁上下可调节长槽留给床头, 床尾安装螺杆用)

e: Use the Big Screw ① to secure the L-shaped angle Bracket ④ to the Side Rail [C] (Location as in Pic)
Note that the long upper and lower adjustable slots in the L-shaped angle Bracket ④ are reserved for mounting Big Screw ① to properly align the Footboard [B] and the Side Rail [C].

步骤2:

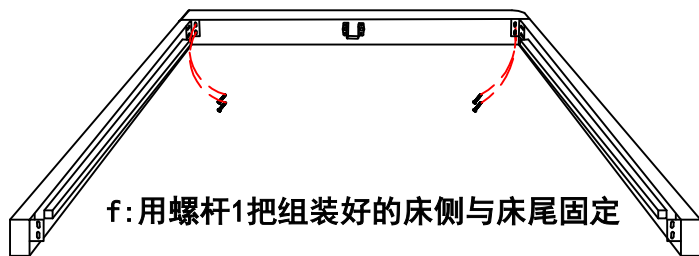

f: 用螺杆1把组装好的床侧与床尾固定

F: Secure the assembled Footboard [B] to the Side Rail [C] with Big Screw ①

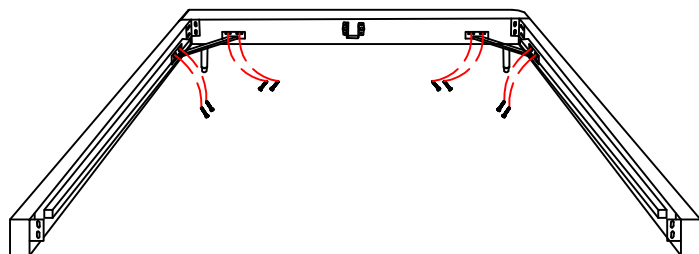

g: 用螺杆1把斜拉杆固定在组装好的床侧与床尾上

g: Secure the Footboard & Side Rail Support ③ to the assembled footboard [B] and side rails [C] with Big Screw ①

步骤3:

h: 用螺杆1把床侧与床头固定

h: Secure the Side Rail [C] and Headboard [A] with Big Screw ①.

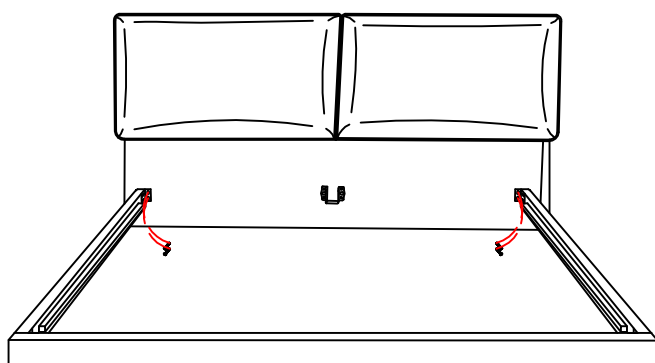

i: 1, 用螺杆1把斜拉杆固定在床侧与床头上

2, 把组装好的床中连杆放入U型角铁内

用2个木螺丝锁住

i: 1. Secure the Footboard & Side Rail Support ③ to the Headboard [A] and side rails [C] with Big Screw ①.

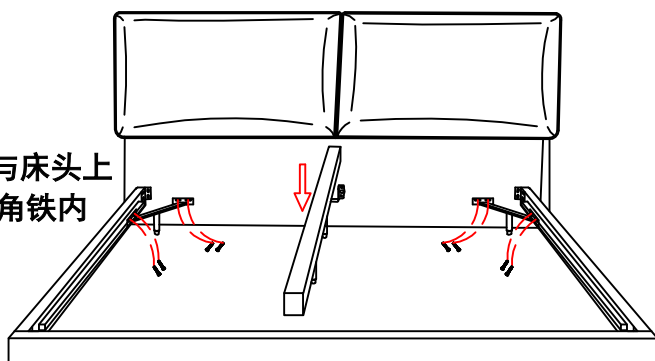

步骤4:

i: 2. Put the assembled Middle Slat [D] into the U-shaped angle Bracket ⑤ and lock it with 2 Small Screws ②.

h: 用木螺丝把床铺板（绷带固定好）固定

h: Secure the Slat [F] (bandage secured) with Small Screws ②.

